

**Carnanelli**  
MOTORI ELETTRICI

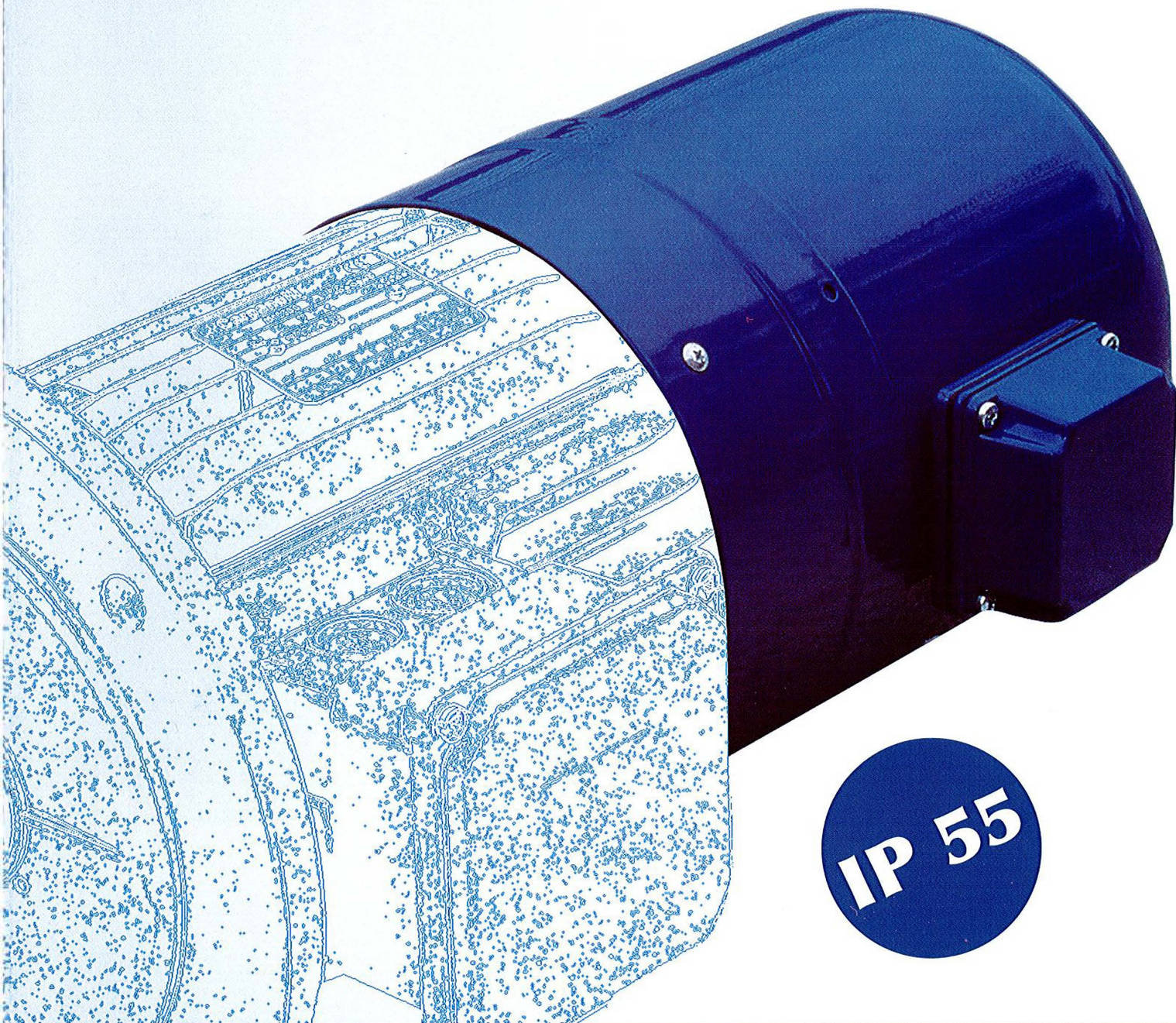

**IP 55**

- \* **COPRIVENTOLA CON SERVOVENTILAZIONE FORZATA**
- \* **FAN COVER WITH FORCED AIR CIRCULATION**
- \* **CACHE-VENTILATEUR AVEC SERVOVENTILATION FORCEE**
- \* **LÜFTERRADABDECKUNG MIT FREMDBELÜFTUNG**

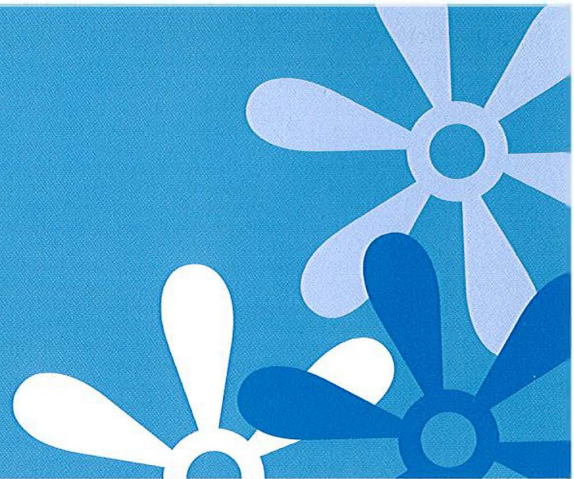



# Carpanelli

## Motori elettrici

**PROLUNGA COPRIVENTOLA**

**FAN COVER EXTENSION**

**RALLONGE CACHE-VENTILATEUR**

**VERLÄNGERUNG FÜR LÜFTERRADABDECKUNG**

**COPRIVENTOLA CON  
SERVOVENTILAZIONE FORZATA**

**FAN COVER WITH FORCED AIR  
CIRCULATION**

**CACHE-VENTILATEUR AVEC  
SERVOVENTILATION FORCEE**

**LÜFTERRADABDECKUNG MIT  
FREMDBELÜFTUNG**

Grandezza Size Taille Baugröße	Ø D	L	L1	L2	L3
M63	123,5	78	14	60	4
M71	138,5	74	8		
M80	156,5	78	12		
M90	176	82	16		
M100	194,5	83	17	80	6
		103			
M112	219,4	86	20	60	
M132	257,5	96	30	60	
M160	310,4	110	24	80	
		134		104	

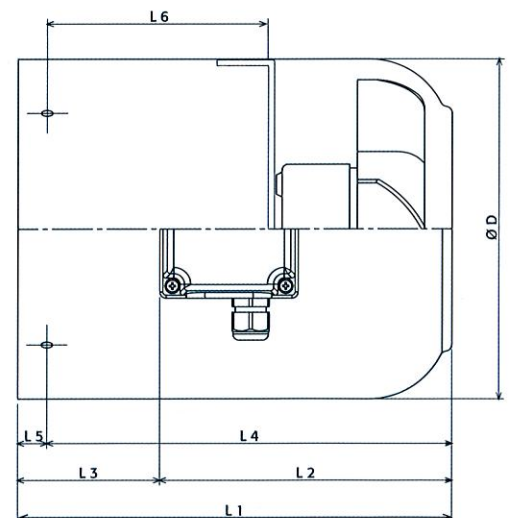
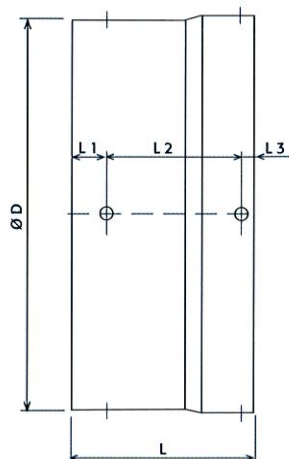
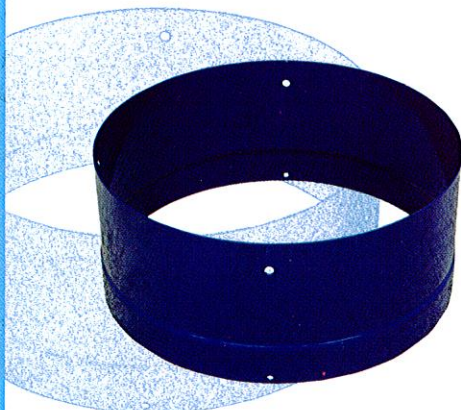



## COPRIVENTOLA CON SERVOVENTILAZIONE FORZATA

I copriventola con servoventilazione forzata trovano largo impiego dove si renda necessaria una variazione di velocità regolata attraverso l'utilizzo di convertitori statici di frequenza e comunque in ogni caso nel quale la ventilazione del motore standard non sia sufficiente a raffreddare il motore. La ventilazione forzata viene realizzata attraverso l'impiego di ventilatori ad alto rendimento.

## FAN COVER WITH FORCED AIR CIRCULATION

Fan covers with forced air circulation are widely used where a speed change controlled by frequency static converters is necessary and in any case where standard motor ventilation is not able to cool the motor. Forced ventilation provides for the use of high-performance fans.

## CACHE-VENTILATEUR AVEC SERVOVENTILATION FORCEE

Les cache-ventilateurs avec servoventilation forcée sont très utilisés en cas de nécessité d'une variation de vitesse réglée à l'aide de convertisseurs statiques de fréquence ainsi que dans tous les cas où la ventilation du moteur standard ne suffit pas à refroidir le moteur. La ventilation forcée est réalisée en utilisant des ventilateurs à haut rendement.

## LÜFTERRADABDECKUNG MIT FREMDBELÜFTUNG

Die Lüfterradabdeckungen mit Fremdbelüftung finden häufig ihren Einsatz in Applikationen, die aufgrund eines Einsatzes statischer Frequenzumrichter eine geregelte Geschwindigkeitsvariation erfordern, und auf jeden Fall überall dort, wo die Standardbelüftung des Motors für dessen Kühlung nicht ausreicht. Die Zwangsbelüftung wird durch den Einsatz hochleistungsfähiger Lüfterräder realisiert.

Grandezza Size Taille Baugröße	Voltaggio V Voltage V Voltage V Volt V	Frequenza Hz Frequency Hz Fréquence Hz Frequenz Hz	Potenza W Power W Puissance W Leistung W	Velocità RPM Speed RPM Vitesse TPM Geschwindigkeit RPM	Portata d'aria m³/h Air Capacity m³/h Débit d'air m³/h Luftdurchsatz m³/h	L1	L2	L3	L4	L5	L6	D
M63 M	230	50	22	2850	144	115	103	12	107	8	41	123
		60	21	3150	162							
	115	50	22	2850	144							
		60	20	3150	162							
M71 M	230	50	22	2850	144	130	99	31	120	10	69	138
		60	21	3150	162							
	115	50	22	2850	144							
		60	20	3150	162							
M71 T	400	50	90	2900	173	190		91	180		67	
	480	60	90	3450	206							
M80 M	230	50	39	2650	272	150	123	27	138	12	64	156
		60	36	2950	306							
	115	50	39	2650	272							
		60	36	2950	306							
M80 T	400	50	90	2900	280	190	156	34	178		69	
	480	60	90	3450	318							
M90 M	230	50	39	2650	272	155	116	39	140	15	76	176
		60	36	2950	306							
	115	50	39	2650	272							
		60	36	2950	306							
M90 T	400	50	90	2850	285	190	148	42	175		76	
	480	60	90	3350	325							
M100 M	230	50	39	2650	280	180	146	34	163	17	91	194
		60	36	2950	320							
	115	50	39	2650	280							
		60	36	2950	320							
M100 T	400	50	90	2900	310						61	
	480	60	90	3400	350							
M112 M	230	50	60	2850	280	200	145	55	185	15	99	220
		60	60	3300	320							
	110	50	50	2850	280							
		60	50	3300	320							
M112 T	400	50	90	2900	310							
	480	60	90	3400	350							
M132 M	230	50	60	2850	280	195	151	94	220	25	92	255
		60	60	3300	320							
	110	50	50	2850	280							
		60	50	3300	320							
M132 T	400	50	90	2900	310	245	174	71,5	220	25	91	225
	480	60	90	3400	350							
M160 M	230	50	130	2870	610	270	180	90	250	20	84	310
		60	205	3360	710							
M160 T	400	50	125	2870	870							
	480	60	190	3430	720							

M = Monofase - Monophase - Monophasé - Einphasig • T = Trifase - Three-phase - Triphasé - Dreiphasig



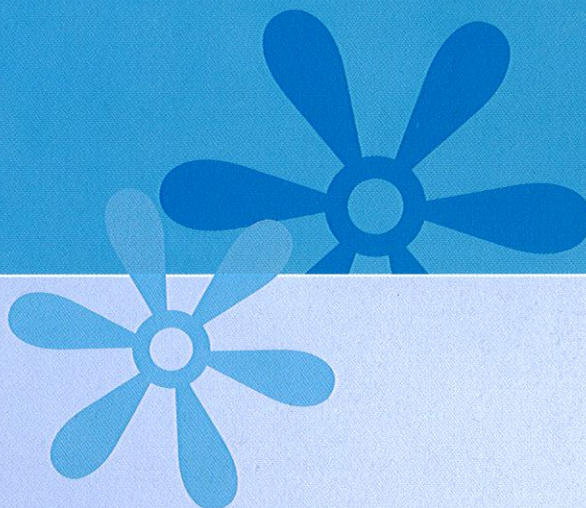

***Carpanelli***  
***Motori elettrici***

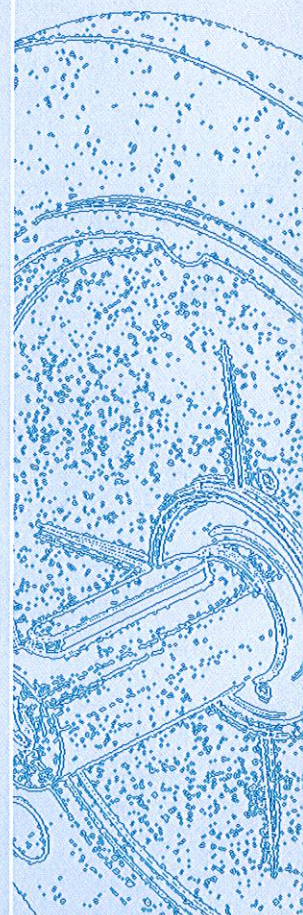

***Via 2 Agosto 1980, 5***  
***40016 San Giorgio di Piano - Bologna - Italy***  
***Tel. +39 051 8902811 Fax +39 051 6651043***

***www.carpanelli.net - info@carpanelli.net***